

HDMI 4x1 Quad Multi-Viewer With Seamless Switcher



Operation Manual

1. Introduction

This product is a high performance 4 by 1 Quad Multi-Viewer with seamless switcher. It supports four High definition input source display on one screen, and have three multi-view effect mode. As a switcher, it can also seamlessly switch the four HD input freely. The product can be controlled by various ways, through the front panel button control, IR control, RS232 control etc. The product provides an S/PDIF link to output the HDMI source audio at the same time. In addition, this product has basic version and extender version. The Extender version can extend the video and audio signals over single 50m CAT5e/6 with Bi-directional IR control.

2. Features

- Compliant with HDMI 1.3a, HDCP 1.2 ;
- Supports multiplexed HDMI 4-input and 1-output ;
- Supports up to 1080p High Definition resolution ;
- Support 4by1 Quad Multi-viewer and seamless switch ;
- Support scaler up, scaler down function ;
- Support multi output resolution ;
- Support digital audio format LPCM/AC3/DTS

- Support button,IR,RS232 etc various controlled ways ;
- IR system allowing for control of source at display end ;
- Allows HDMI Audio/Video and IR signals to be transmitted over a single Cat5e/6 cable(**Extender Version**).

3. Package Contents

Basic Version

- HDMI Quad Multi-Viewer 1pcs
- 12V/2.5A DC power adaptor 1pcs
- Remote Control 1pcs
- Wide-band IR Receiver 1pcs
- Wide-band IR Transmitter 4pcs
- RS232 Cable 1pcs
- Operation Manual 1pcs

Extender Version

- HDMI Quad Multi-Viewer 1pcs
- CAT5e/6 Receiver 1pcs
- 12V/2.5A DC power adaptor 1pcs
- 5V/1A DC power adaptor 1pcs
- Remote Control 1pcs
- Wide-band IR Receiver 2pcs
- Wide-band IR Transmitter 5pcs
- RS232 Cable 1pcs
- Operation Manual 1pcs

4. Specification

Video Bandwidth	2.25Gbps
Input Ports	4 × HDMI (Female type),1x RS232;
Output Ports	1 × HDMI (Female type),1xRCA, 1xUTP(Extender version)
Audio output	PCM2, 5.1, 7.1CH, Dolby 5.1, DTS5.1
Input Resolution	480i60Hz,480p60Hz,576i50Hz,576p50Hz,720p50/60Hz, 1080i50/60Hz,1080p24/30/50/60Hz,800x600@60, 1024x768@60,1280x720@60,1920x1080@60;
Output Resolution	1080p,1080i,720p,1024x768,1360x768
ESD Protection	Human Body model: ±8 kV (air-gap discharge) ±4 kV (contact discharge)
Power Supply	12 V/2.5A DC (US/EU standards, CE/FCC/UL certified)
Dimensions	118mm(W) X 250mm (D) X 32mm(H)
Weight	750 g

Chassis Material	Metal
Silkscreen Color	Black
Operating Temperature	0 °C~40 °C/ 32 °F~104 °F
Storage Temperature	-20 °C ~ 60 °C/-4 °F ~140 °F
Relative Humidity	20~90 % RH (non-condensing)
Power Consumption	10 W

5. Operation and Functions

5.1 Front panel

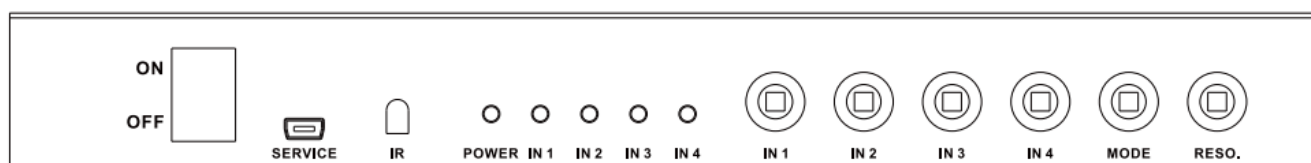

1. **ON/OFF:** Power on/off switch.
2. **SERVICE:** For factory use only.
3. **IR :** Remote control receiver window.
4. **POWER LED:** This red LED illuminates when the device is connected with power supply.
5. **IN1,2,3,4 LED:** These red LED illuminates when the output select to the corresponding input.
6. **INPUT BUTTON:** Press this button to select the input source.
7. **MODE BUTTON:** Press this button to select the multi-view display mode.
※see the detail description below(chapter 5.7).
8. **RESO BUTTON:** Press this button to select the HDMI output resolution.

5.2 Rear panel (Basic Version)

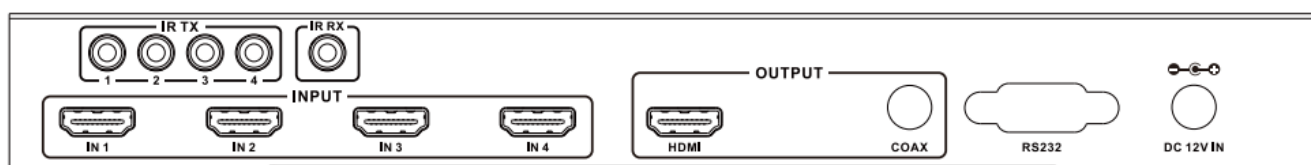

1. **Input:** These slot is where you connect the HDMI source output from DVD, PS3,Set-top Box and Note Book.
2. **OUTPUT:** The HDMI is where you connect the HDTV or monitor with HDMI cable for input source display.The Coax is where you connect to the amplifier with coaxial cable.
3. **IR RX:** Connect to the IR Receiver for IR signal reception. Ensure that remote being used is within the direct line-of-sight of the IR receiver.
4. **IR TX:** Connect the IR Blaster cable included in the package for IR signal transmission. Pace the IR blaster in direct line-of-sight of the equipment to be controlled.

5. **RS232:** Connect the RS232 port to the PC or notebook by RS232 Cable.
6. **DC 12V:** Plug the 12V DC power supply into the unit and connect the adaptor to AC wall outlet.

5.3 Rear panel (Extender Version)

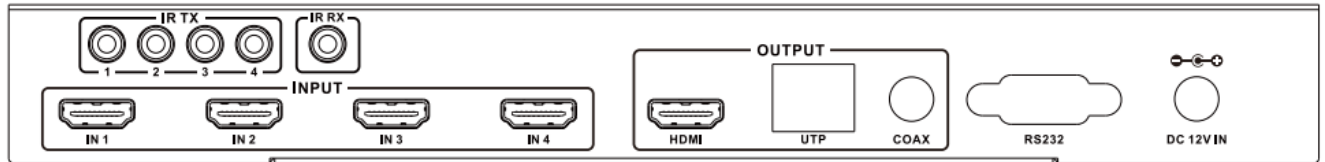

1. **Input:** These slot is where you connect the HDMI source output from DVD, PS3,Set-top Box and Note Book.
2. **OUTPUT:** The HDMI is where you connect the HDTV or monitor with HDMI cable for input source display.*The UTP port connect to CAT Receiver by CAT5e/6 cable for signal extend.*The Coax is where you connect to the amplifier with coaxial cable.
3. **IR RX:** Connect to the IR Receiver for IR signal reception. Ensure that remote being used is within the direct line-of-sight of the IR receiver.
4. **IR TX:** Connect the IR Blaster cable included in the package for IR signal transmission. Pace the IR blaster in direct line-of-sight of the equipment to be controlled.
5. **RS232:** Connect the RS232 port to the PC or notebook by RS232 Cable.
6. **DC 12V:** Plug the 12V DC power supply into the unit and connect the adaptor to AC wall outlet.

5.4 CAT Receiver(Extender Version)

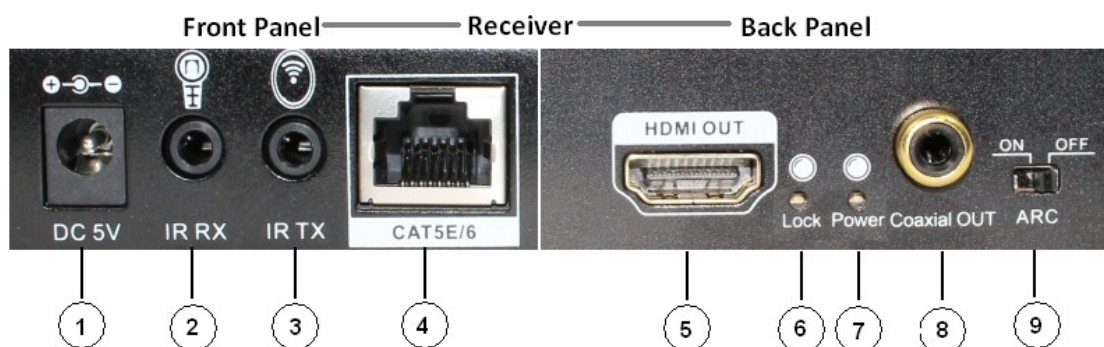

- 1 **DC 5V:** Connect from 5V DC power supply into the unit and connect the adaptor to an AC outlet.
- 2 **IR RX:** Connect to the IR Receiver for IR signal reception. Ensure that remote being used is within the direct line-of-sight of the IR receiver.
- 3 **IR TX:** Connect the IR Blaster cable included in the package for IR signal transmission. Pace the IR blaster in direct line-of-sight of the equipment to be controlled.

- 4 **CAT5E/6:**Connect the CAT input of the receiver with the CAT output of the transmitter with CAT5E/6 cable.
- 5 **HDMI OUT:** This slot is to connect the HDMI input port of your display such as an HDTV.
- 6 **LOCK LED:** This LED will illuminate when the HDMI signal from the transmitter is stable.
- 7 **Power LED:** This LED will illuminate when the device is connected with power supply.
- 8 **Coaxial out:** This slot is where you connect to the audio amplifier with coaxial cable.
- 9 **ARC :** Switch the ARC switcher will open or close the ARC function.

ARC function : If you need use ARC,your HDTV must support this function, When you open the ARC function,the coaxial of the receiver will output the HDTV current display content audio signal. Otherwise will output the HDMI source(DVD,set-top-box ,etc) audio signal.

5.5 Connect and Operate

1. Connect the signal sources such as Blu-Ray Player, Play Station 3, audio/video receiver, satellite receivers and computers equipped with HDMI output interfaces with a short high-speed HDMI cable to the HDMI Switcher inputs.
2. Connect the HDMI output of the HDMI Switcher to a high-definition display device such as HD-LCD, HD-DLP and HD projectors with HDMI input interfaces. Use high-speed HDMI cables that are recommended for the distances that are required for each connection.
3. The Switcher is powered by an external power supply which is included. Connect power first to the source, then to the Switcher and then to HD TV or projector.
4. The input source can be controlled from the display. This is accomplished by using an optional IR Receiver pigtail pointing away from the display(s), which can be connected with an optional HDMI IR Adapter , and inserted between HDMI cable connector and display with the toggle switcher at the "IR" position. The IR Transmitter pigtail is used to connected to the switcher and pointed to the source(s). The switcher also have a capability of being controlled via Remote control.

5.6 Wideband IR(30KHz---60KHz) introduction

IR RECEIVER



IR BLASTER

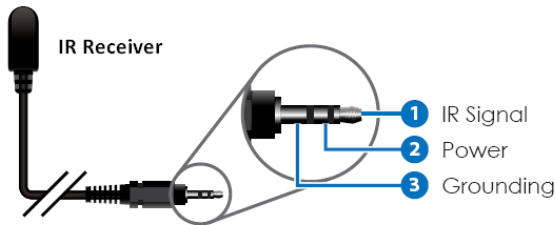
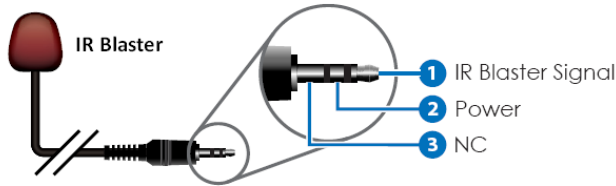

IR BLASTER (TX)

To control the source: Plug IR Blaster into IR TX port of transmitter unit; place blaster in front of the IR eye of the source.

IR RECEIVER (RX)

To control the source: Plug IR Receiver into IR RX port of receiver unit; place receiver at or near display.

5.7 Detail description of display mode

The quad multi-viewer have 3 display modes.

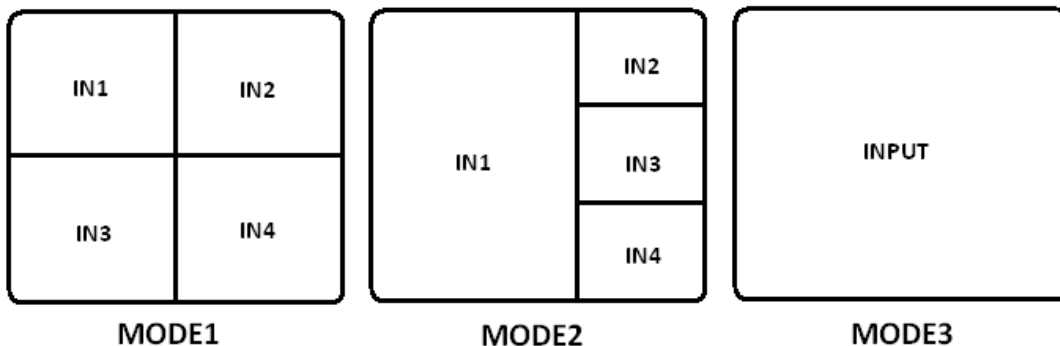

MODE1: The quad multi-viewer divides the four HD input to the same size and display on one screen. And now switch the input button on front panel or IR remote, the HDMI output audio will correspond to the selected input source.

MODE2: The quad multi-viewer divides the four HD input to one bigger and three

smaller picture display on one screen. And now switch the input button on front panel or IR remote, the bigger picture will correspond to the selected input source. The HDMI output audio follows the bigger picture source.

MODE3: The quad multi-viewer will separately display the four HD inputs, and now it is a seamless switcher.

6. Remote Control

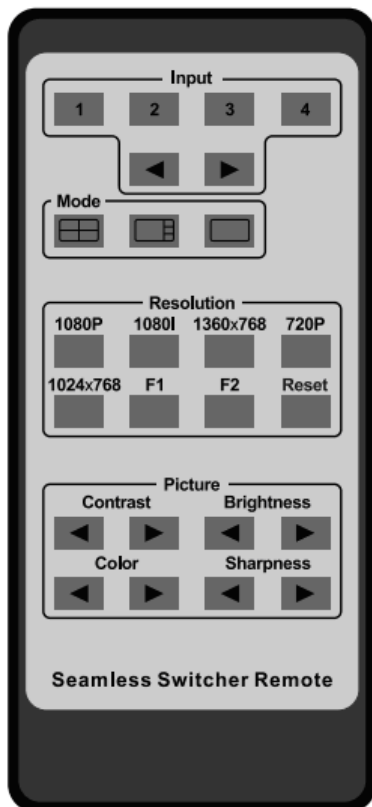

1. **Input select button:** press these buttons, the quad multi-viewer will select the corresponding input source, the front panel LED will indicate the selected input source status.

2. **Mode select button:** press these buttons, the quad multi-viewer will select the corresponding mode, see the detail description (chapter 5.7).

3. **Resolution button:** press these buttons, the HDMI will output different resolution, 1080p, 1080i, 720p, 1024x768, 1360x768.

The F1, F2 button expands for user-defined function. Press the Reset button, the quad multi-viewer will reset to factory state.

4. **Picture button:** press these buttons can adjust the display picture contrast, brightness, color, and sharpness.

7. PC controller user guide

Installation

The PC controller is green software. Just use a cable to connect the PC via RS232 port and copy "Quad multi-viewer.exe" to PC to complete installation.

Preparation

1. Connect PC and multi-viewer by RS232 cable (headers of both sides of cable should be FEMALE)
2. Power-up multi-viewer
3. Double click Quad multi-viewer.exe icon to run it

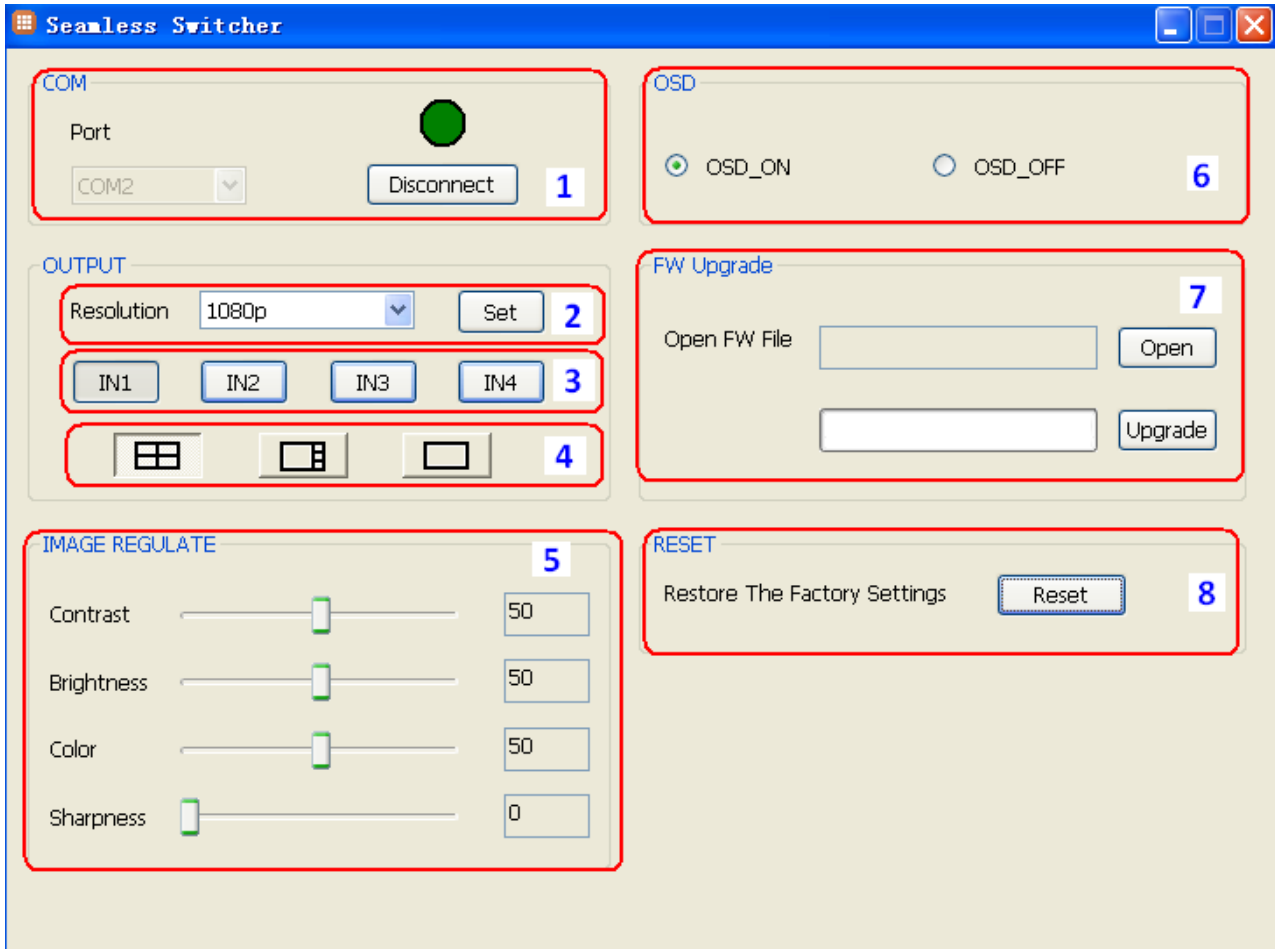

1. Select PC connect COM port, Click to connect or disconnect PC and multi-viewer.
2. Select the HDMI output resolution.
3. Select the input source.
4. Select the output mode, see the detail description(chapter 5.7).
5. Adjust the HDMI output picture quality.
6. Display or hidden the OSD menu.
7. FW upgrade part:Click to open Firmware.the click the upgrade button,the new firmware will auto download to the multi-viewer and restar it.
8. Press the Reset button,the quad multi-viewer will reset to factory state.

8. Connection Diagram

Basic version:

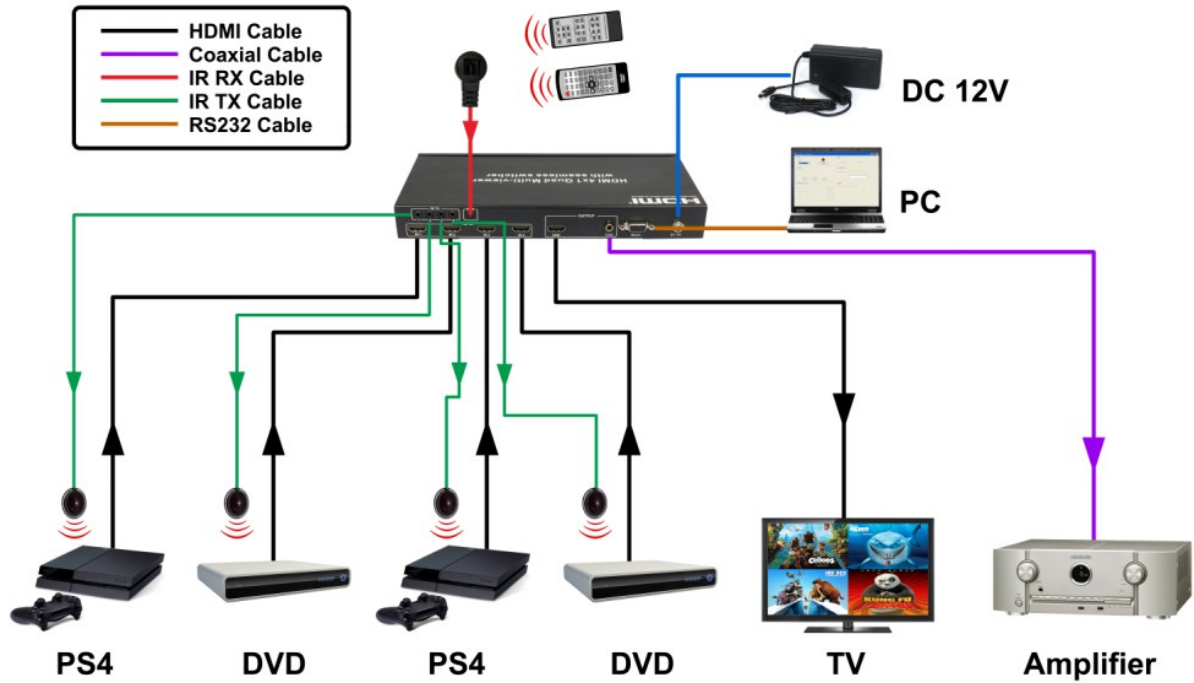

Extender version:

